

# SG 1003

---

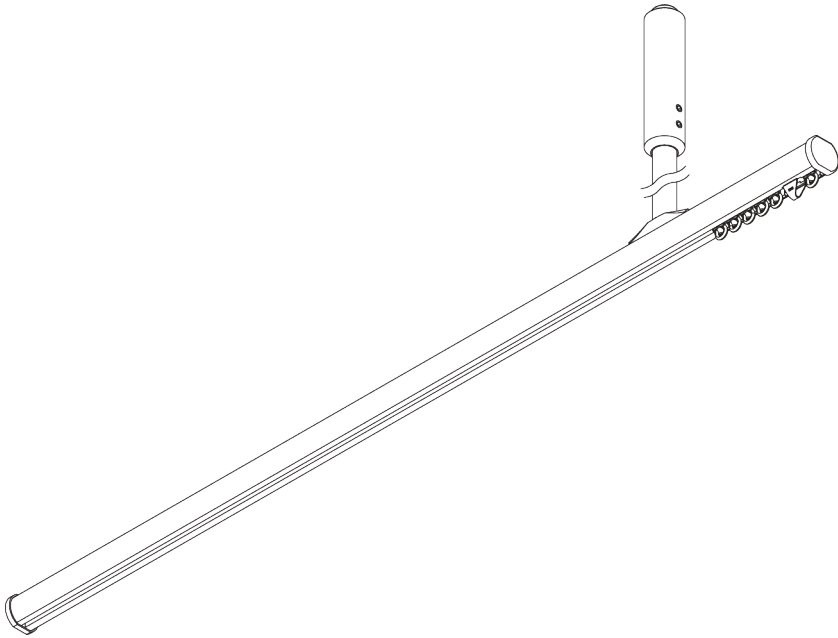

## PRODUCT INFORMATION

- **Operation:** hand
- **Range:** S
- **Fitting:** suspended, wall, ceiling
- **Colours:** white RAL 9016 or anodised aluminum, special colours possible
- **Fabrics:** refer to Silent Gliss fabric collection

### **Features:**

- Bendable
- Suspended

# SYSTEM SPECIFICATIONS

## A. PROFILE

Profile and bending information

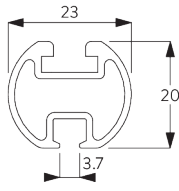

**SG 1003p**

Profile

Radius:  
✓ 15 cm, 20 cm, >25 cm

## B. HOW TO MEASURE

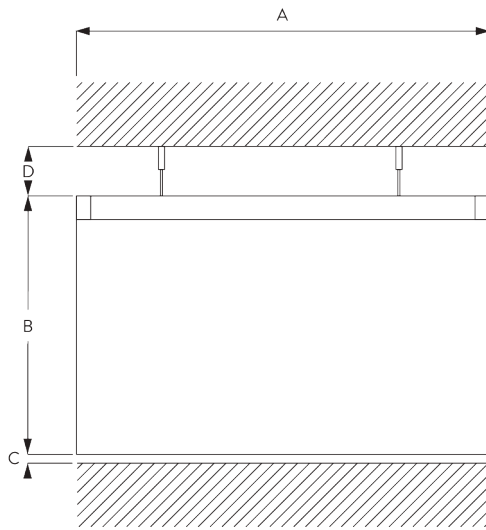

A: System width

B: System height

C: Distance between floor and fabric

D: Distance between ceiling and system

## C. SPECIFICATION TEXT

### EN

Silent Gliss SG 1003 Cubicle Curtain Track System. Comprises aluminium profile SG 1003 supplied made to measure in silver anodised or powder coated in white with gliders SG 3533/SG 3089 at 14/m. 2 stops SG 3070. 2 End caps SG 3014. Top fixed with SG 6124/SG 6190 at 800-1500 mm centres. Wall fixed with SG Smart Fix at 800-1500 mm centres.

### SV

Silent Gliss SG 1003 dusch/draperi system. Består av aluminiumprofil SG 1003 i specificerad längd i vitlack, alu natur eller angiven RAL färg. 14 st SG 3533/3089 glid med krok per meter. 2 ändstopp SG 3070. Ändskydd SG 3014. Takmonteras med fäste SG 6124/SG 6190 c/c 800-1500 mm. Vägghängning med SG Smart Fix c/c 800-1500 mm.

### NO

Silent Gliss SG 1003 Dusj- og Cubiclesystem Består av aluminiumprofil SG 1003 i spesifisert lengde. Hvitlakkert, alu natur eller spesifisert RAL farge. 14 st SG 3533/3089 glidere m/krok pr meter. 2 stk endestopp SG 3014. Takmonteres med feste SG 6124/SG6190 c/c 800-1500 mm. Veggmontering med SG Smart Fix c/c 800-1500 mm.

### DA

Silent Gliss SG 1003 gardinskinnesystem til kabiner. Består af aluminiumprofil SG 1003 i ønsket længde, sølvanodiseret eller hvid pulverlakering med 14 stk. glidere SG 3533/SG 3089 pr. m. 2 stop SG 3070. 2 endelåg SG 3014. Loftmonteres med SG 6124/SG 6190 i afstande på 800-1500 mm. Vægmonteres med SG Smart Fix med en afstand på 800-1500 mm.

# FITTING

## A. FITTING INFORMATION

For detailed fitting information, visit the Silent Gliss website.

### Fixing points

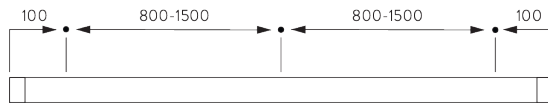

### Dust cover

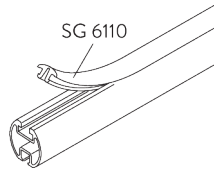

## B. CEILING FITTING

### Hanger SG 6190 / SG 6196

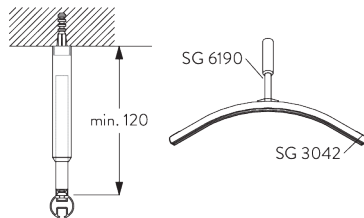

Or variant with SG 6196 double hanger.

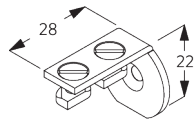

**SG 3042**  
Wall bracket

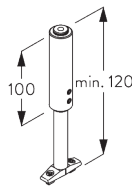

**SG 6190**  
Hanger

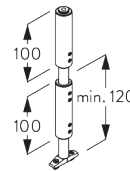

**SG 6196**  
Double hanger

### Mini hanger SG 6175

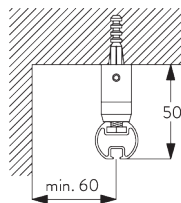

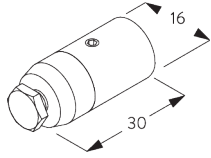

**SG 6175**

Mini hanger

**Bracket SG 6124**

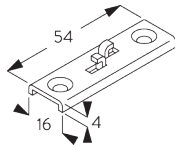
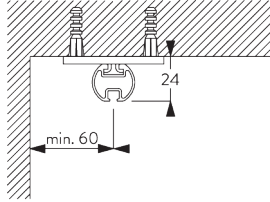

**SG 6124**

Bracket

**C. WALL FITTING**

**Smart Fix**

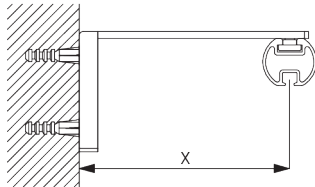

**Smart Fix with slot SG 11206 - SG 11208:**  
Screw SG 10492 (M4x8) needed.

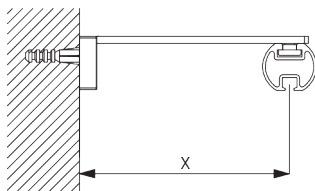

**Square Smart Fix with slot SG 11216 - SG 11218:**  
Screw SG 10492 (M4x8) needed.

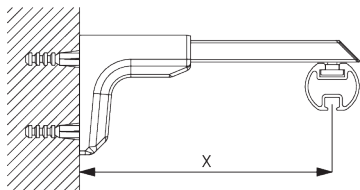

**Universal Smart Fix SG 11154 - SG 11156:**  
Screw SG 11131 (M4x6) needed.

Smart Fix	X mm
SG 11206 / SG 11216	33-51
SG 11207 / SG 11217	53-71
SG 11208 / SG 11218	73-91
SG 11154	102-130
SG 11155	132-160
SG 11156	182-210

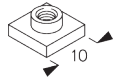

**SG 6117**  
Slot nut



**SG 10492**  
Pan head screw M4x8



**SG 11131**  
Pan head screw with flange  
M4x6

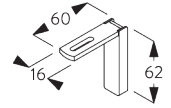

**SG 11206**  
Smart Fix with slot 60 mm

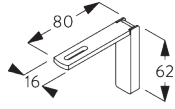

**SG 11207**  
Smart Fix with slot 80 mm

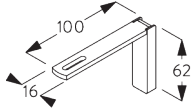

**SG 11208**  
Smart Fix with slot 100 mm

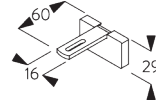

**SG 11216**  
Square Smart Fix with slot 60  
mm

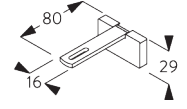

**SG 11217**  
Square Smart Fix with slot 80  
mm

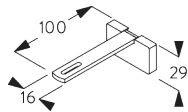

**SG 11218**  
Square Smart Fix with slot  
100 mm

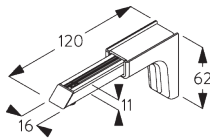

**SG 11154**  
Universal Smart Fix 120 mm

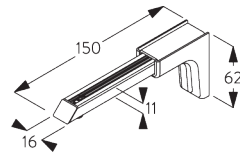

**SG 11155**  
Universal Smart Fix 150 mm

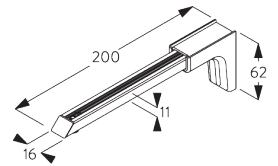

**SG 11156**  
Universal Smart Fix 200 mm

# PARTS

## A. STANDARD PARTS



**SG 1003p**

Profile

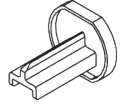

**SG 3014**

End cover



**SG 3070**

End stop

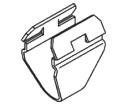

**SG 3085**

Spring stop



**SG 3533**

Glider

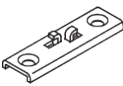

**SG 6124**

Bracket

## B. OPTIONAL PARTS

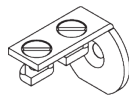

**SG 3042**

Wall bracket



**SG 3534**

Glider 3533 on strip

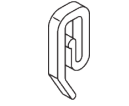

**SG 3582**

Hook

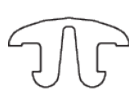

**SG 6110**

Dust cover

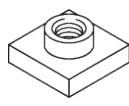

**SG 6117**

Slot nut

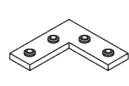

**SG 6125**

Corner connection piece

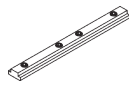

**SG 6173**

Connection bridge

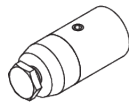

**SG 6175**

Mini hanger



**SG 6190**

Hanger



**SG 6196**

Double hanger



**SG 6501**

V-Hanger



**SG 6530**

V-Hanger

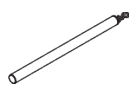

**SG 10430**

Draw rod 50 cm

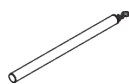

**SG 10431**

Draw rod 75 cm

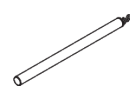

**SG 10432**

Draw rod 100 cm



**SG 10433**

Draw rod 125 cm

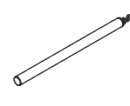

**SG 10434**

Draw rod 150 cm

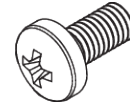

**SG 10492**

Pan head screw M4x8

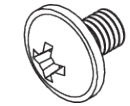

**SG 11131**

Pan head screw with flange M4x6

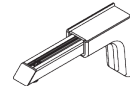

**SG 11154**

Universal Smart Fix 120 mm

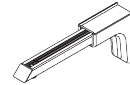

**SG 11155**

Universal Smart Fix 150 mm

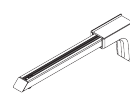

**SG 11156**

Universal Smart Fix 200 mm

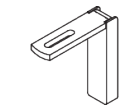

**SG 11206**

Smart Fix with slot 60 mm

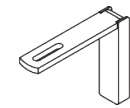

**SG 11207**

Smart Fix with slot 80 mm

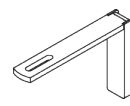

**SG 11208**

Smart Fix with slot 100 mm

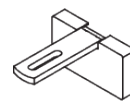

**SG 11216**

Square Smart Fix with slot 60 mm

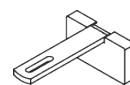

**SG 11217**

Square Smart Fix with slot 80 mm

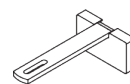

**SG 11218**

Square Smart Fix with slot 100 mm

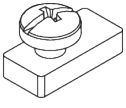

---

**SG 11335**

---

*End stop*

---

