

SG 4760

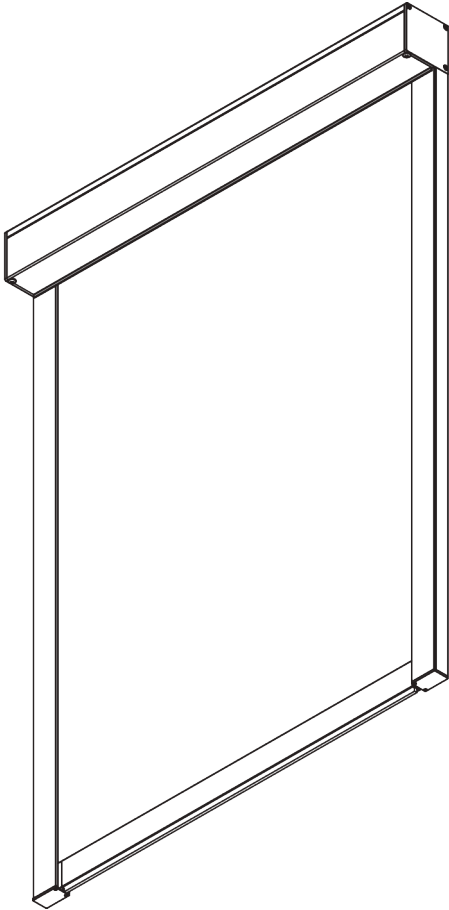
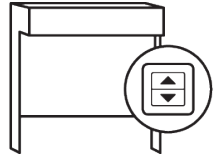

PRODUCT INFORMATION

- **Operation:** motorised
- **Range:** S
- **Fitting:** ceiling, wall, recess
- **Colours:** white RAL 9016 or black RAL 9005, special colours possible
- **Fabrics:** refer to Silent Gliss fabric collection

Features:

- Zip technology
- Quiet and fast motors
- Soft stop
- Various control options
- 40 mm side channel, pre-drilled fixing points

SYSTEM SPECIFICATIONS

A. SYSTEM DIMENSIONS



1.6 m

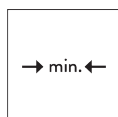

65 cm

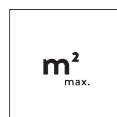

1.6 m

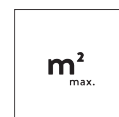

2.5 m²



2 kg

B. PROFILE

Profile information

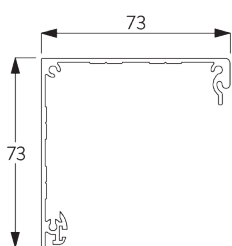

SG 10994

Box case 73 mm

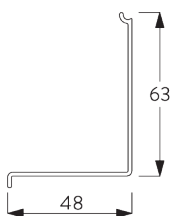

SG 10995

Box cover 73 mm

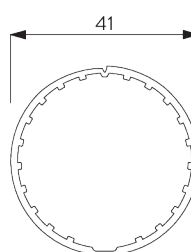

SG 10532

Tube ø 41 mm

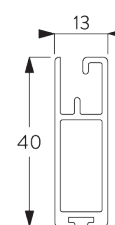

SG 10993

Bottom bar

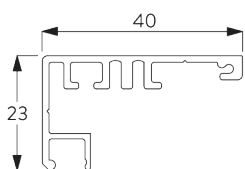

SG 11418

Side guide case

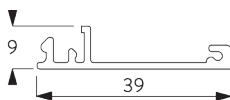

SG 11419

Side guide cover

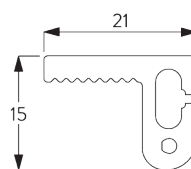

SG 11421

Zip profile

C. HOW TO MEASURE

Inside fitting

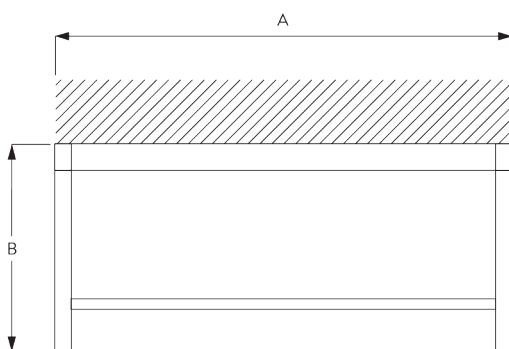

A: System width
B: System height



Face fitting

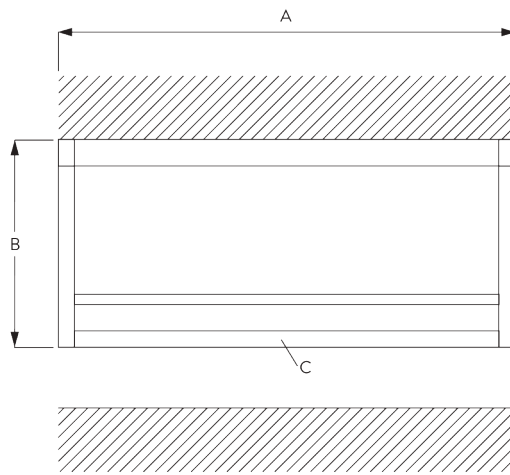

- A: System width
- B: System height
- C: Optional: end profile (SG 11418 / SG 11419)

D. SPECIFICATION

TEXT

EN

Silent Gliss SG 4760 Electrically Operated Dim-Out Roller Blind System with SG Series 20 motors. For blinds up to 1.6m wide by 1.6m drop, max 2.5sq.m. Supplied complete and made to measure comprising aluminium headbox SG 10994-5 (73 mm), side profiles SG 11418 / SG 11419 and bottom hem bar SG 10993 in white or black powder coat finish as standard.

Fabric edges retained by two component zip profile SG 11421. Operation by mains switch (not supplied) or mains switching by third party control system or SG 0450 remote control system (wireless controls at extra cost). All wiring to be strictly in accordance with Silent Gliss wiring diagrams. Fabric to be chosen from the Silent Gliss fabric range, Price Group 1R / 2R / 3R.

SV

Silent Gliss SG 4760 mörkläggningsrullgardin med motor serie 20. För system max 1,6 x 1,6 m, eller totalt max 2,5 m². Levereras komplett i kundmått bestående av toppkassett i aluminium SG 10994-5 (73 mm), sidoprofiler SG 11418 / SG 11419 samt tyngdprofil SG 10993 i vit eller svart epoxy lack. Textilens kant försedd med zip profil SG 11421. Integrerad 230V motor SG 10320 / (SG 10321 radiomottagare) vänster / höger sida. Styrning via väggkontakt (ej inkluderad), via fjärrkontroll eller via externt styrsystem. All elinstallation skall följa Silent Gliss kopplingschema. Textil från Silent Gliss textilprogram i prisgrupp 1-3.

NO

Silent Gliss SG 4760 Mørkleggende rullegardin med motor serie 20. For system inntil 1,6 x 1,6 m, eller totalt max 2,5 m². Levereras komplett måltilpasset. Består av toppkasse i aluminium SG 10994-5 (73 mm), sideprofiler SG 11418 / SG 11419 samt tyngdeprofil SG 10993 i hvit eller svart epoxy lakk. Sidene på tekstile er festet med zip profil SG 11421. Integrert 230V motor SG10320 / (SG 10321 radiomottaker) venstre eller høyre side. Betjenes med veggbryter (ikke inkludert), fjernkontroll eller via eksternt styrsystem. Ved alle elektriske installasjoner skal Silent Gliss koblingskjema benyttes. Tekstiler fra Silent Gliss tekstilkolleksjon i prisgrupp 1-3.

FITTING

A. FITTING INFORMATION

For detailed fitting information, visit the Silent Gliss website.

Inside fitting - fixing points

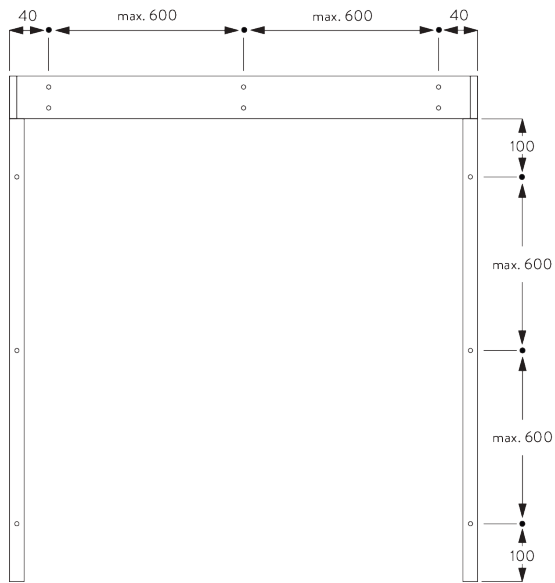

Face fitting - fixing points

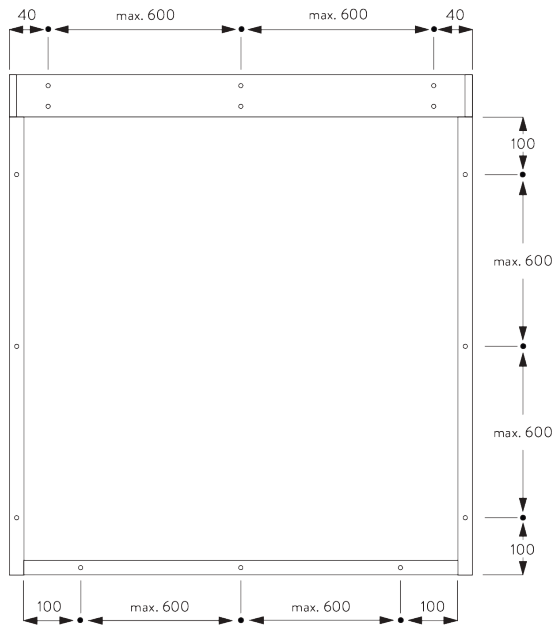

B. CEILING FITTING

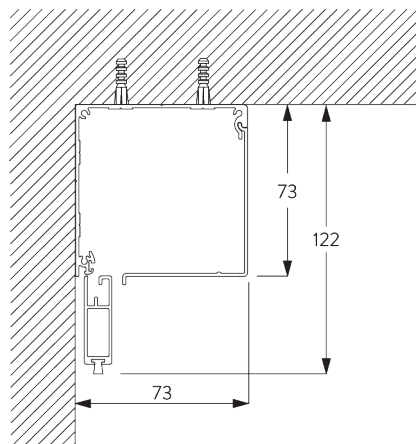

C. WALL FITTING

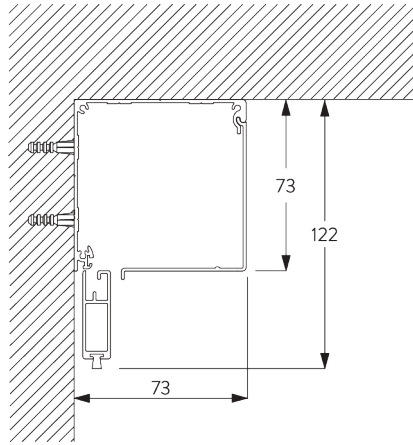

D. RECESS FITTING

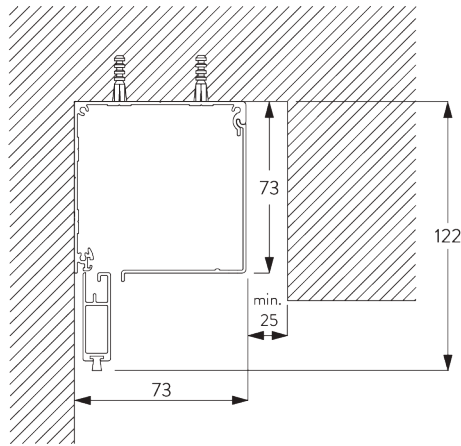

E. SIDE PROFILES
SG 11418 / SG 11419

Inside fitting

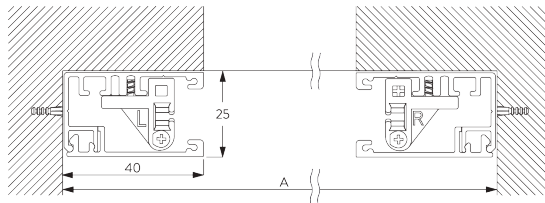

A: System width

Face fitting

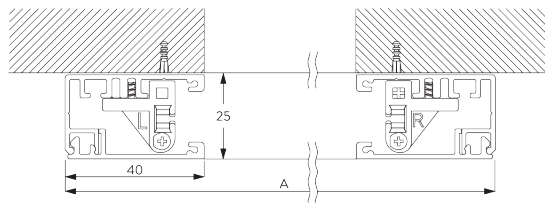

A: System width

MOTORS & CONTROLS

A. MOTOR FEATURES

Motors	20-Series	20-Series	10-Series K	5-Series
	SG10523	SG10522	SG10514	SG10715

Motor Features

Soft stop	●	●		
Electronic end-stop	●	●		
Electronic revolution counter (unlimited revolution)	●	●		
Mechanical end-stop			●	●
Mechanical revolution counter (limited revolution)			●	●
Two intermediate positions possible	●			
Noiseless stop	●	●	●	
Parallel wiring possible without additional relays	●	●		
Disconnectable motor cable	●	●		
IP class	IP 44	IP 44	IP 44	IP 44

Control Features

Mains power control	●	●	●	●
SG Control L (built-in receiver)	●			
Suitable for most major home automation systems (with suitable interface)	●	●	●	●

B. MOTOR SPECIFICATIONS

Motors	Min. system width	Voltage	Current	Frequency	Speed	Frequency receiver
20-Series						
SG10522 (standard)	65 cm	230 V AC	0.55 A	50 Hz	30 rpm	-
SG10523	65 cm	230 V AC	0.55 A	50 Hz	30 rpm	868/915 MHz
10-Series K						
SG10514	65 cm	230 V AC	0.52 A	50 Hz	30 rpm	-
5-Series						
SG10715	65 cm	230 V AC	0.485 A	50-60 Hz	28 rpm	-

C. OPERATING METHODS

See catalogue "controls" for details.

Wall Switch



System can be operated by fixed wall switch.

SG Control L



Various radio hand-held and wall transmitters available.



Silent Gliss Move App.











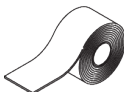
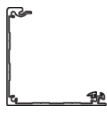
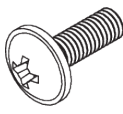
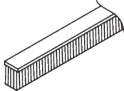

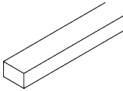
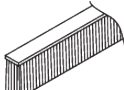

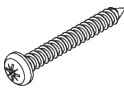
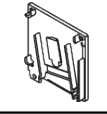
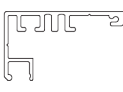
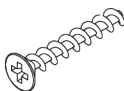
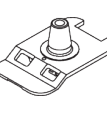

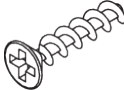
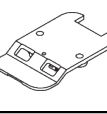

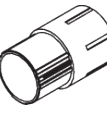
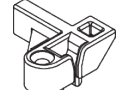
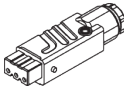
D. WIRING
DIAGRAMS

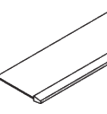
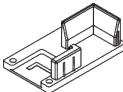

Refer to Silent Gliss website.

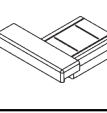
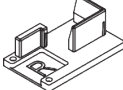
PARTS

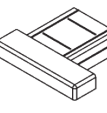
A. STANDARD PARTS

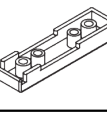
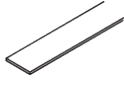
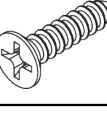
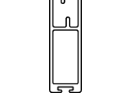
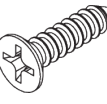
	SG 4226 Double tape 30 mm		SG 10994 Box case 73 mm		SG 11059 Pan head screw with flange M4x12
	SG 4508 Brush 5x7 mm		SG 10995 Box cover 73 mm		SG 11060 Foam tape adhesive
	SG 4509 Brush 5x12 mm		SG 11004 End cover left 73 mm		SG 11324 PT Screw Countersunk KA35x14
	SG 6791 Pan head screw 3.9x32		SG 11005 End cover right 73 mm		SG 11418 Side guide case
	SG 6933 PT Countersunk screw KA25x16		SG 11011 Clip		SG 11419 Side guide cover
	SG 6936 PT Countersunk screw KA22x10		SG 11013 Clip		SG 11421 Zip profile
	SG 6942 Pan head screw KA30x8		SG 11014 Tube adapter		SG 11473 Zip guide left
	SG 9917 Hirschmann portable socket-outlet STAK 3 N		SG 11016 Tube adapter		SG 11474 Zip guide right
	SG 10284 O-Ring		SG 11025 Zip		SG 11475 Side guide end cover left
	SG 10522 Motor 230V AC, 20-Series S 3/30		SG 11028 End cover left		SG 11476 Side guide end cover right
	SG 10532 Tube ø 41 mm		SG 11029 End cover right		
	SG 10623 Motor drive		SG 11030 Cover		
	SG 10668 PVC strip 10 mm		SG 11034 Countersunk head screw 3.5x16		
	SG 10993 Bottom bar		SG 11035 Countersunk head screw 2.2x9.5		

B. OPTIONAL PARTS

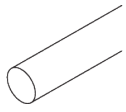

SG 4951

Bottom weight ø 8 mm

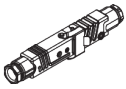

SG 9916

Hirschmann plug set

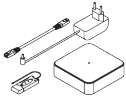

SG 9960

Move server set

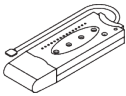

SG 9961

Move transmitter

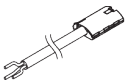

SG 10293

Cable 230V AC, 2/3/5/10 m

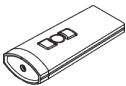

SG 10300

Radio hand held 1 channel



SG 10302

Radio hand held 5+1 channel



SG 10303

Radio hand held 10+2+1 channel

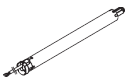

SG 10514

Tubular motor 230V AC, 10 Series S
3/30 K



SG 10523

Motor 230V AC, 20-Series S 3/30,
radio receiver



SG 10715

Tubular motor 230V AC, 5 Series S
6/28



SG 10804

Radio hand held 15+5+1 channel



SG 11480

Radio wall transmitter 1 channel



SG 11490

Radio wall transmitter 5+1 channel

