

# SG 1012

---

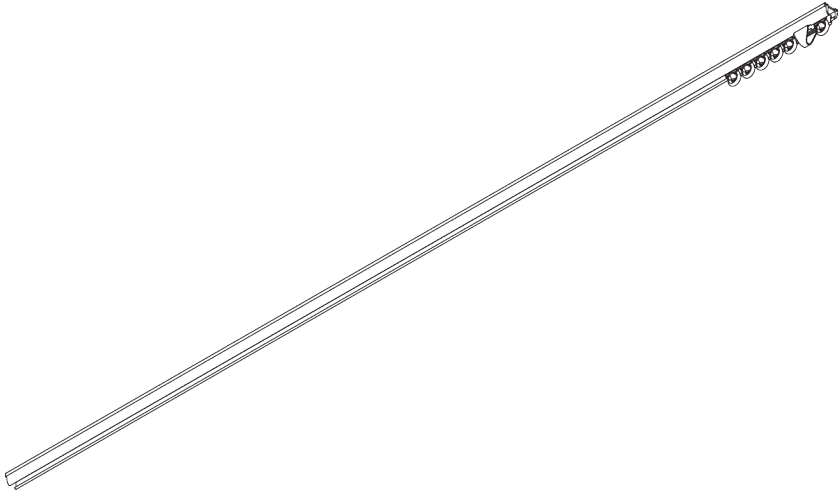

## PRODUCT INFORMATION

- **Operation:** hand
- **Range:** S
- **Fitting:** recess (center SG 7550)
- **Colours:** white RAL 9016 or anodised aluminum, special colours possible
- **Fabrics:** refer to Silent Gliss fabric collection

### **Features:**

- Pre-drilled profile
- Bendable

# SYSTEM SPECIFICATIONS

## A. PROFILE

Profile and bending information

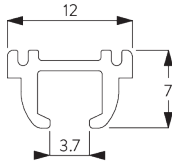

SG 1012p

Profile

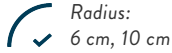

## B. HOW TO MEASURE

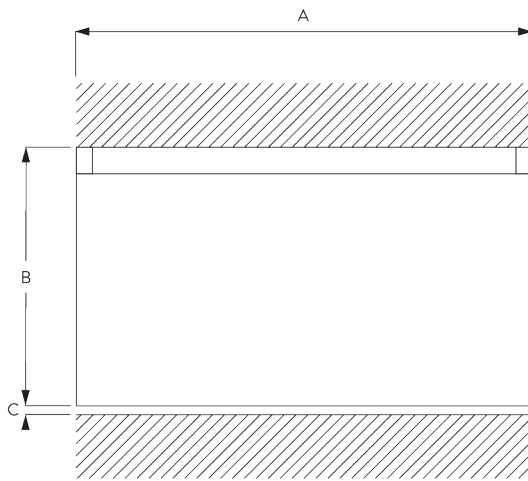

A: System width

B: System height

C: Distance between floor and fabric

## C. SPECIFICATION

TEXT

### EN

Silent Gliss SG 1012 Hand Drawn Curtain Track System. Comprises aluminium profile SG 1012 supplied made to measure in silver anodised or white powder coated, alternatively a specified RAL colour. SG 3533 at 14/m and 2 end covers SG 3512/ end stops SG 3070/SG 3085 Spring stops per length. Top fixed with brackets SG 3112/3121 at max. 120 mm centres. Or directly to ceiling with screws SG 3019/3025.

### SV

Silent Gliss SG 1012 handdragssystem. Består av aluminiumprofil SG 1012 i specificerad längd i vitlack, alu natur eller angiven RAL färg. 14 st SG 3533 glid per meter, 2 st SG 3512 ändskydd samt 2 st SG 3070 vridstopp/SG 3085 fjäder per system. Takmonteras med fäste SG 3112/3121 c/c 120 mm. Alternativt skruvas direkt i tak m skruv SG 3019/SG 3025.

### NO

Silent Gliss SG 1012 manuell gardinskinne. Består av aluminiumprofil SG 1012 i spesifisert lengde, standard i hvitlakkert eller alu natur. Kan også leveres i spesifisert RAL farge. 14 stk SG 3533 glidere pr meter, 2 stk SG 3070 vridstopp/SG 3085 fjær pr system. Takmonteres med feste SG3112/3121 c/c 120 mm. Alternativt skrues skinnen direkte i taket med skruer SG 3019/SG 3025.

### DA

Silent Gliss SG 1012 håndtrukket gardinskinnesystem. Består af en aluminiumprofil SG 1012 i ønsket længde, sølvanodiseret eller hvid pulverlakering, alternativt en specificeret RAL-farve. 14 stk. SG 3533 pr. m og 2 stk. SG 3512 endelåg eller SG 3070/SG 3085 fjeder pr. længde. Loftmonteres med beslagene SG 3112/3121 med højst 120 mm afstand. Eller direkte i loftet med skruer SG3019/3025.

# FITTING

## A. FITTING INFORMATION

For detailed fitting information, visit the Silent Gliss website.

### Fixing points

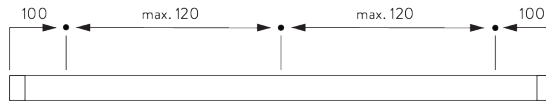

### Profile Protector

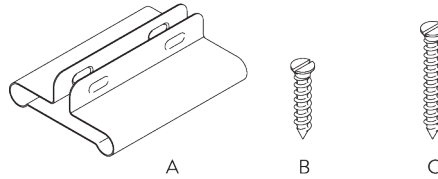

A: Profile Protector SG 7002  
 B: Special Screw SG 3019 / 12 mm  
 C: Special Screw SG 3025 / 18 mm

## B. CEILING FITTING

### Direct into wood

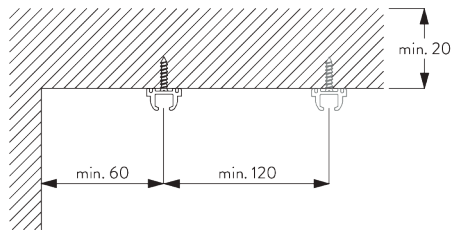

### Bracket SG 3112

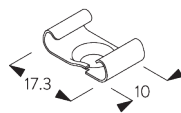
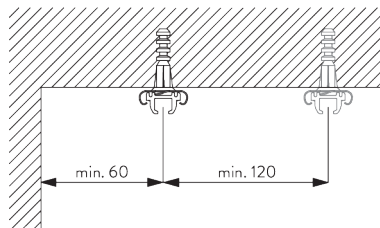

SG 3112  
 Bracket

## Bracket SG 3121

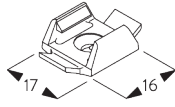
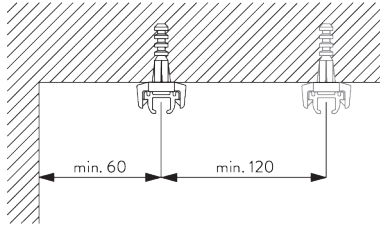





---



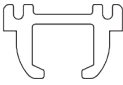
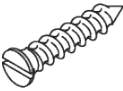











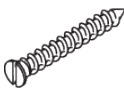

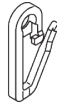
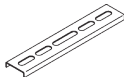

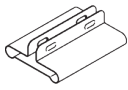
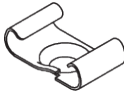
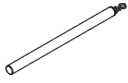
**SG 3121**  
*Bracket*

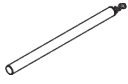
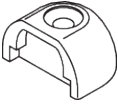
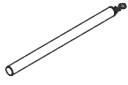
# PARTS

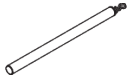
## A. STANDARD PARTS

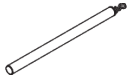
	<b>SG 1012p</b> Profile
	<b>SG 3019</b> Special screw 12 mm
	<b>SG 3070</b> End stop
	<b>SG 3085</b> Spring stop
	<b>SG 3533</b> Glider

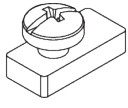
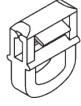
## B. OPTIONAL PARTS

	<b>SG 3016</b> End stop		<b>SG 3570</b> Glider
	<b>SG 3020</b> Hook		<b>SG 3571</b> Hook
	<b>SG 3025</b> Special screw 18 mm		<b>SG 3582</b> Hook
	<b>SG 3032</b> Spring stop		<b>SG 3598</b> Eyelet
	<b>SG 3064</b> Connecting bridge		<b>SG 3599</b> Hook
	<b>SG 3071</b> End stop		<b>SG 7002</b> Profile protector
	<b>SG 3112</b> Bracket		<b>SG 10430</b> Draw rod 50 cm
	<b>SG 3511</b> Glider		<b>SG 10431</b> Draw rod 75 cm
	<b>SG 3512</b> End cover		<b>SG 10432</b> Draw rod 100 cm
	<b>SG 3534</b> Glider 3533 on strip		<b>SG 10433</b> Draw rod 125 cm
	<b>SG 3535</b> Glider		<b>SG 10434</b> Draw rod 150 cm
	<b>SG 3537</b> Glider		<b>SG 11335</b> End stop
	<b>SG 3548</b> Glider		
	<b>SG 3549</b> Click glider with hook		





