

# SG 6380

---

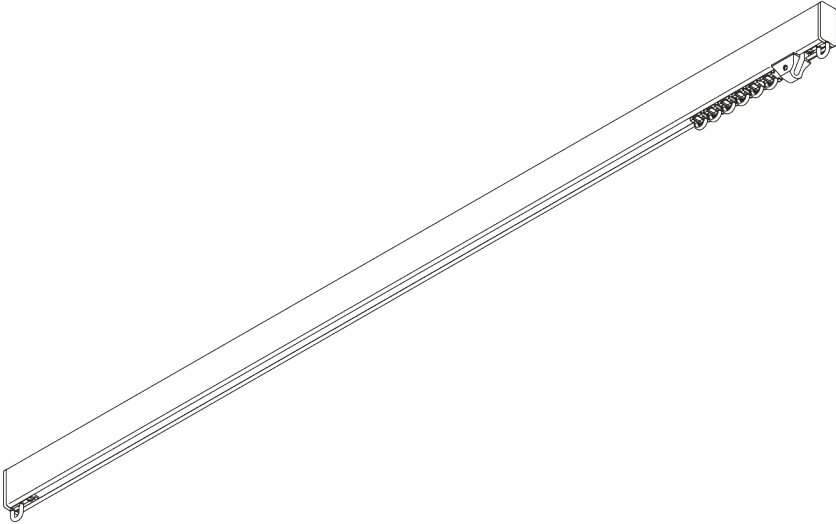

## PRODUCT INFORMATION

- **Operation:** hand
- **Range:** M - L
- **Fitting:** ceiling, wall
- **Colours:** white RAL 9016 or anodised aluminum, special colours possible
- **Fabrics:** refer to Silent Gliss fabric collection

### **Features:**

- 2-component (2C) glider technology
- Wave (2C)
- Bendable

# SYSTEM SPECIFICATIONS

## A. PROFILE

Profile and bending information

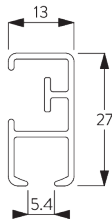

**SG 6380p**

Profile

Radius:  
10 cm, >25 cm

## B. HOW TO MEASURE

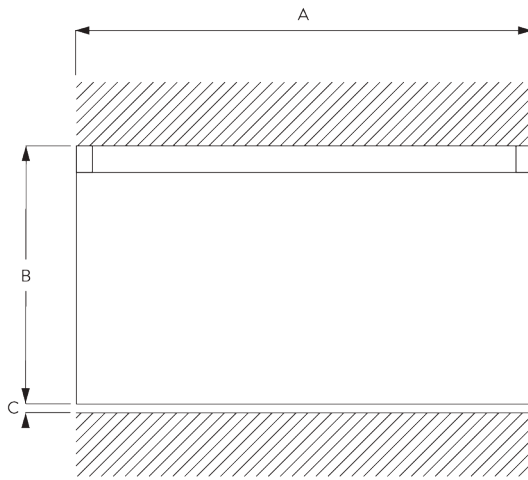

A: System width

B: System height

C: Distance between floor and fabric

## C. SPECIFICATION TEXT

### EN

Silent Gliss SG 6380 Hand Drawn Curtain Track System. Comprises aluminium profile SG 6380 supplied made to measure in silver anodised or white powder coated, alternatively a specified RAL colour. SG 11130 at 14/m and 2 end covers SG 6381. Top fixed with brackets SG 3603 at max. 600 mm centres / wall fix SG Smart Fix at max. 600 mm centres. Silent Gliss Wave option is available.

### SV

Silent Gliss SG 6380 handdragssystem. Består av aluminiumprofil SG 6380 i specificerad längd i vitlack, alu natur eller angiven RAL färg. 14 st SG 11300 SILENT TRACK glid per meter, 2 st SG 6381 ändskydd per system. Takmonteras med fäste SG 3603 c/c 600 mm. Vägghäring med SG 3603 och Smart Fix c/c 600 mm. Kan användas med system Wave.

### NO

Silent Gliss SG 6380 Manuell gardinskinne. Består av aluminiumprofil SG 6380 i spesifisert lengde, standard i hvitlakkert eller alu natur. Kan også leveres i spesifisert RAL farge. 14 stk SG 11300 SILENT TRACK glidere pr meter, 2 stk SG 6381 endeløkk pr system. Takmonteres med feste 3603 c/c 600 mm. Veggmontering med SG 3603 og smart Fix c/c 600 mm. Kan benyttes med Wave system.

### DA

Silent Gliss SG 6380 håndtrukket gardinskinnesystem. Består af en aluminiumprofil SG 6380 i ønsket længde, sølvanodiseret eller hvid pulverlakering, alternativt en specificeret RAL-farve. 14 stk. SG 11130 pr. m og 2 stk. SG 6381 endelæg. Loftmonteres med beslagene SG 3603 med højst 600 mm afstand. Vægmonteres med SG Smart Fix med højst 600 mm afstand Kan bruges med Silent Gliss Wave.

# FITTING

## A. FITTING INFORMATION

For detailed fitting information, visit the Silent Gliss website.

### Fixing points

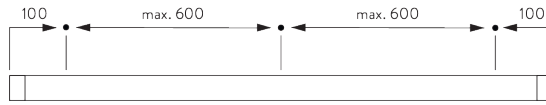

## B. CEILING FITTING

### Bracket SG 3603

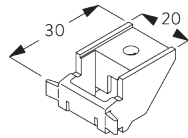
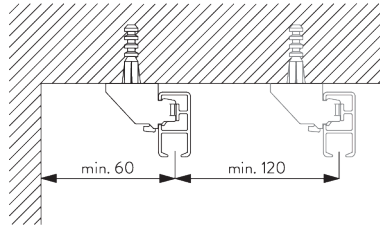

**SG 3603**  
Bracket

## C. WALL FITTING

### Smart Fix

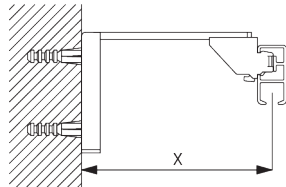

**Smart Fix SG 11200 - SG 11205 and bracket SG 3603:**  
Screw SG 10492 (M4x8) needed.

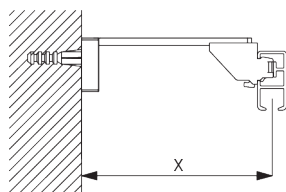

**Square Smart Fix SG 11210 - SG 11215 and bracket SG 3603:**  
Screw SG 10492 (M4x8) needed.

Smart Fix	X mm
SG 11200 / SG 11210	72
SG 11201 / SG 11211	92
SG 11202 / SG 11212	112
SG 11203 / SG 11213	132
SG 11204 / SG 11214	162
SG 11205 / SG 11215	212
SG 11154	122-150
SG 11155	152-180
SG 11156	202-230

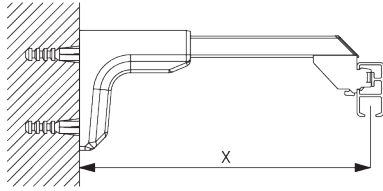

**Universal Smart Fix SG 11154 - SG 11156 and  
bracket SG 3603:**

Screw SG 10277 (M4x12) needed.

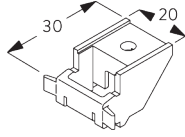

**SG 3603**

Bracket



**SG 10277**

Pan head screw M4x12



**SG 10492**

Pan head screw M4x8

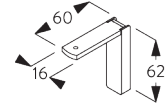

**SG 11200**

Smart Fix 60 mm

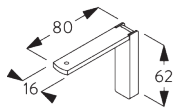

**SG 11201**

Smart Fix 80 mm

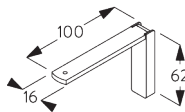

**SG 11202**

Smart Fix 100 mm

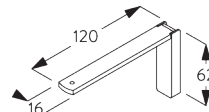

**SG 11203**

Smart Fix 120 mm

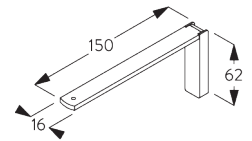

**SG 11204**

Smart Fix 150 mm

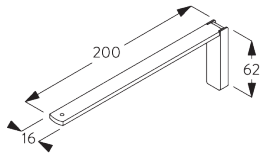

**SG 11205**

Smart Fix 200 mm

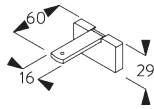

**SG 11210**

Square Smart Fix 60 mm

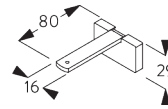

**SG 11211**

Square Smart Fix 80 mm

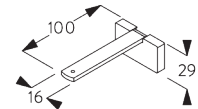

**SG 11212**

Square Smart Fix 100 mm

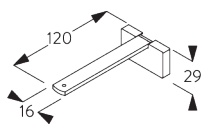

**SG 11213**

Square Smart Fix 120 mm

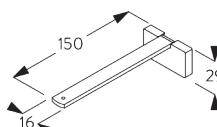

**SG 11214**

Square Smart Fix 150 mm

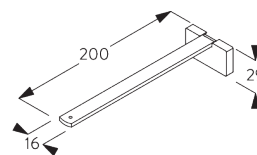

**SG 11215**

Square Smart Fix 200 mm

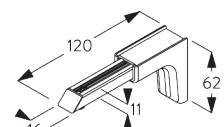

**SG 11154**

Universal Smart Fix 120 mm

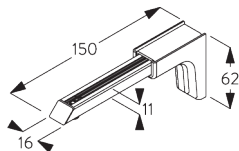

**SG 11155**

Universal Smart Fix 150 mm

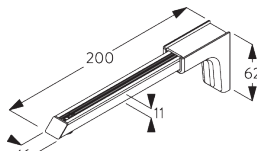

**SG 11156**

Universal Smart Fix 200 mm

**Universal Brackets  
SG 3630, SG 3655,  
SG 3660**

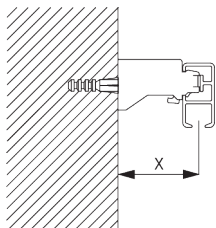

<b>Bracket</b>	<b>X mm</b>
SG 3630	35
SG 3655	50
SG 3660	65

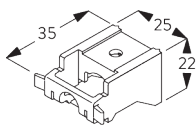

**SG 3630**  
Bracket 35 mm

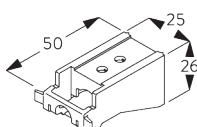

**SG 3655**  
Bracket 50 mm

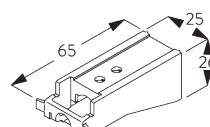

**SG 3660**  
Bracket 65 mm

# SYSTEM OPTIONS

## A. WAVE

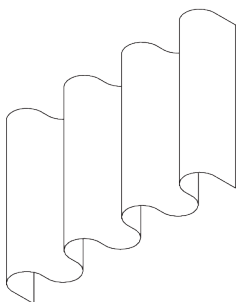

SG 11295

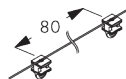

SG 11302

Standard components:

- SG 11295 End stop
- SG 11302 Wave 2C glider cord 80 mm



SG 2255



SG 2256

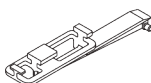

SG 6364



SG 6365

Optional components (min. radius >25 cm):

- SG 2255 Brake
- SG 2256 Brake
- SG 6364 Wave extension
- SG 6365 Wave hanger
- SG 6366 Wave carrier for draw rod
- SG 10430-34 Draw rod
- SG 11303 Wave 2C glider cord 60 mm

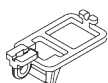

SG 6366

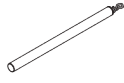

SG 10430-34

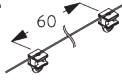

SG 11303

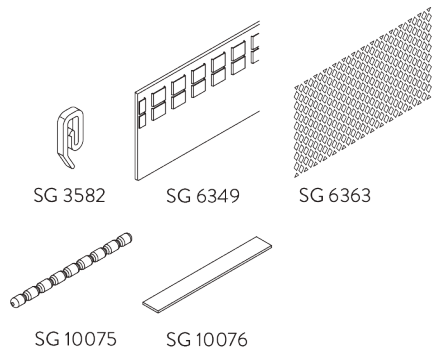

Curtain components:

- SG 3582 Hook
- SG 6349 Wave curtain tape
- SG 6363 Wave top hemming tape
- SG 10075 Lead weight 50 gr/m
- SG 10076 Fabric weight

Wave stack depth - 2C glider cord (standard components)

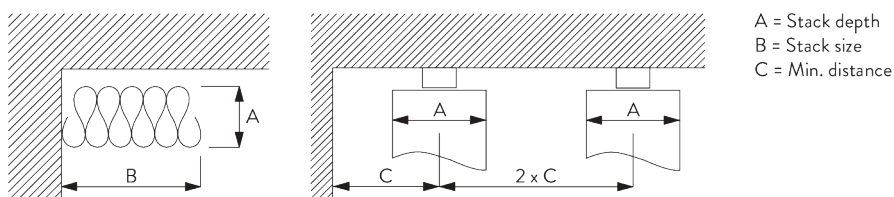

A = Stack depth  
 B = Stack size  
 C = Min. distance







2C Glider cord SG 11302	Pockets between hooks	Approx. curtain fullness	Stack depth A	Stack size B*	Min distance C
80	6	~2.1	140	180 per metre of track	90
80	7	~2.3	160	180 per metre of track	100

2C Glider cord SG 11303	Pockets between hooks	Approx. curtain fullness	Stack depth A	Stack size B*	Min distance C
60	4	~2.1	100	230 per metre of track	70
60	5	~2.3	120	230 per metre of track	80

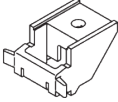



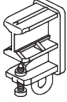





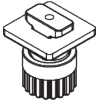

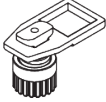



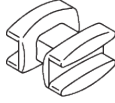

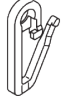

\*Stack size B when using optional extension arm increases by 150 mm per curtain stack!

# PARTS

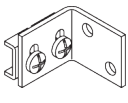
## A. STANDARD PARTS

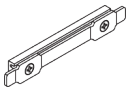
	<b>SG 3599</b> Hook
	<b>SG 3603</b> Bracket
	<b>SG 6065</b> End stop
	<b>SG 6086</b> Spring stop
	<b>SG 6380p</b> Profile
	<b>SG 6381</b> End cover
	<b>SG 11300</b> 2C glider

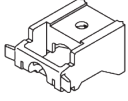
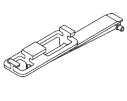
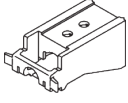
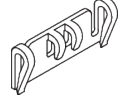
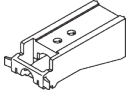
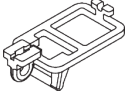
## B. OPTIONAL PARTS

	<b>SG 2255</b> Brake		<b>SG 6005</b> Hook
	<b>SG 2256</b> Brake		<b>SG 6053</b> Spring stop
	<b>SG 3012</b> Hook		<b>SG 6057</b> Glider
	<b>SG 3555</b> Hook		<b>SG 6082</b> Glider
	<b>SG 3571</b> Hook		<b>SG 6094</b> Roller
	<b>SG 3581</b> Hook		<b>SG 6098</b> Roller
	<b>SG 3582</b> Hook		<b>SG 6240</b> Roller
	<b>SG 3598</b> Eyelet		<b>SG 6283</b> Roller
	<b>SG 3618</b> Wall bracket		<b>SG 6349</b> Wave curtain tape
	<b>SG 3620</b> Connection bridge		<b>SG 6363</b> Wave top hemming tape
	<b>SG 3630</b> Bracket 35 mm		<b>SG 6364</b> Wave extension
	<b>SG 3655</b> Bracket 50 mm		<b>SG 6365</b> Wave hanger
	<b>SG 3660</b> Bracket 65 mm		<b>SG 6366</b> Wave carrier for draw rod
	<b>SG 6004</b> Eyelet		<b>SG 10075</b> Lead weight 50 g/m

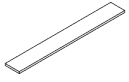

**SG 10076**

Fabric weight

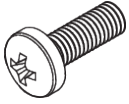

**SG 10277**

Pan head screw M4x12

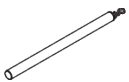

**SG 10430**

Draw rod 50 cm

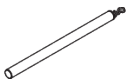

**SG 10431**

Draw rod 75 cm

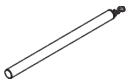

**SG 10432**

Draw rod 100 cm

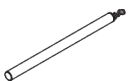

**SG 10433**

Draw rod 125 cm

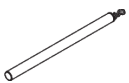

**SG 10434**

Draw rod 150 cm



**SG 10492**

Pan head screw M4x8

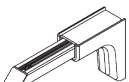

**SG 11154**

Universal Smart Fix 120 mm

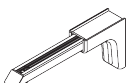

**SG 11155**

Universal Smart Fix 150 mm

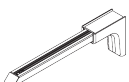

**SG 11156**

Universal Smart Fix 200 mm

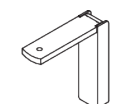

**SG 11200**

Smart Fix 60 mm

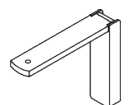

**SG 11201**

Smart Fix 80 mm

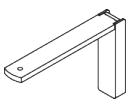

**SG 11202**

Smart Fix 100 mm

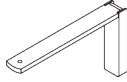

**SG 11203**

Smart Fix 120 mm



**SG 11204**

Smart Fix 150 mm

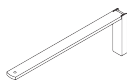

**SG 11205**

Smart Fix 200 mm

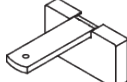

**SG 11210**

Square Smart Fix 60 mm

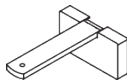

**SG 11211**

Square Smart Fix 80 mm

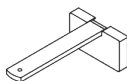

**SG 11212**

Square Smart Fix 100 mm

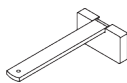

**SG 11213**

Square Smart Fix 120 mm

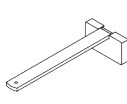

**SG 11214**

Square Smart Fix 150 mm

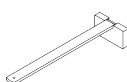

**SG 11215**

Square Smart Fix 200 mm



**SG 11295**

End stop



**SG 11301**

2C glider on strip

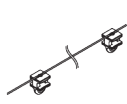

**SG 11302**

Wave 2C glider cord 80 mm

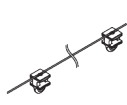

**SG 11303**

Wave 2C glider cord 60 mm

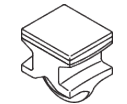

**SG 11305**

2C glider for direct sewing