

SG 6815

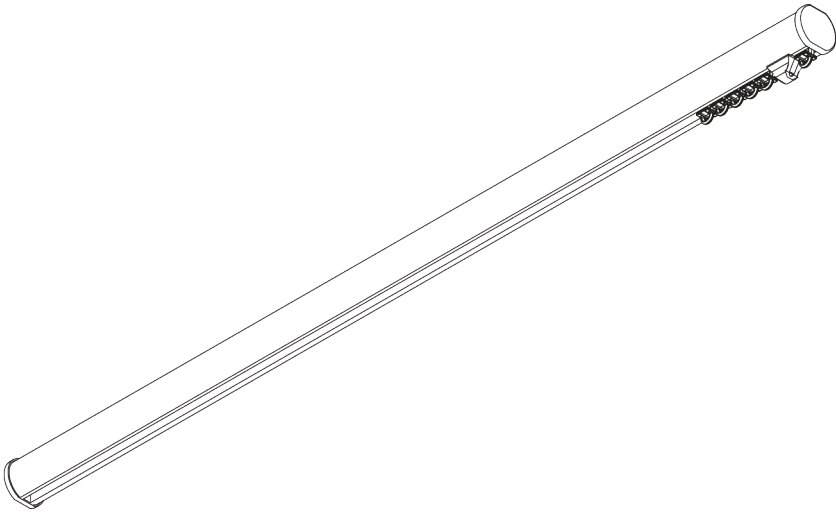

PRODUCT INFORMATION

- **Operation:** hand
- **Range:** S - M
- **Fitting:** ceiling, wall
- **Colours:** white RAL 9016 or anodised aluminum, special colours possible
- **Fabrics:** refer to Silent Gliss fabric collection

Features:

- 2-component (2C) glider technology
- Wave (2C)
- Bendable

SYSTEM SPECIFICATIONS

A. PROFILE

Profile and bending information

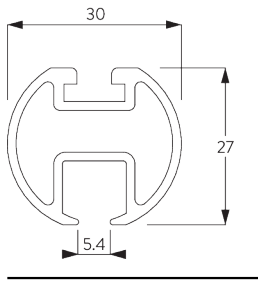

SG 6103p

Profile



Radius: >25 cm

B. HOW TO MEASURE

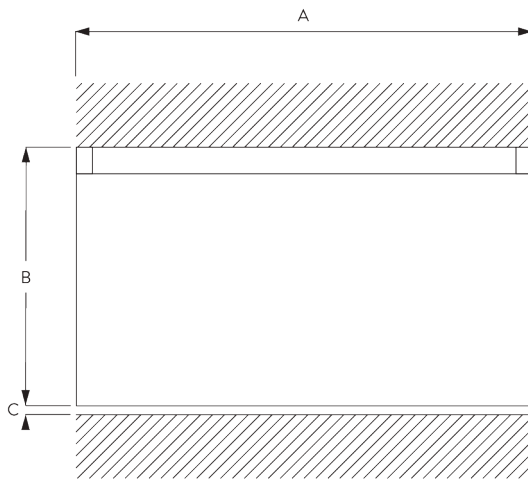

A: System width

B: System height

C: Distance between floor and fabric

C. SPECIFICATION

TEXT

EN

Silent Gliss SG 6815 Hand Drawn Curtain Track System. Comprises aluminium profile SG 6103 supplied made to measure in silver anodised or white powder coated, alternatively a specified RAL colour. SG 11130 at 14/m, 2 end covers SG 6630 and 2 SG 6065 stops. Top fixed with brackets SG 6124/6175 at max. 800 mm centres / wall fix SG Smart Fix at max. 800 mm centres. Silent Gliss Wave option is available.

SV

Silent Gliss SG 6815 handdragssystem. Består av aluminiumprofil SG 6103 i specificerad längd i vitlack, alu natur eller angiven RAL färg. 14 st SG 11300 SILENT TRACK glid per meter, 2 st SG 6630 ändskydd samt 2 st SG 6065 vridstopp per system. Takmonteras med fäste SG 6124/6175 c/c 800 mm. Kan användas med system Wave.

NO

Silent Gliss SG 6815 Manuell gardinskinne. Består av aluminiumprofil SG 6103 i spesifisert lengde, standard i hvitlakkert eller alu natur. Kan også leveres i spesifisert RAL farge. 14 stk SG 11300 SILENT TRACK glidere pr meter, 2 stk 6630 endelokk og 2 stk SG 6065 vristopp pr system. Takmonteres med feste SG 6124/ 6175 c/c 800 mm. Kan kombineres med Wave system.

DA

Silent Gliss SG 6815 håndtrukket gardinskinnesystem. Består af en aluminiumprofil SG 6103 i ønsket længde, sølvanodiseret eller hvid pulverlakering, alternativt en specificeret RAL-farve. 14 stk. SG 11130 glidere pr. m og 2 stk. SG 6630 endelåg samt 2 stk. SG 6065 endestop. Loftmonteres med beslagene SG 6124/6175 medhøjest 800 mm afstand. Vægmonteres med SG Smart Fix med højest 800 mm afstand. Kan bruges med Silent Gliss Wave.

FITTING

A. FITTING INFORMATION

For detailed fitting information, visit the Silent Gliss website.

Fixing points

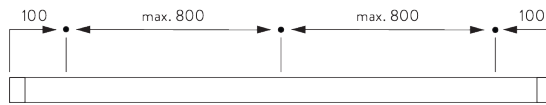

B. CEILING FITTING

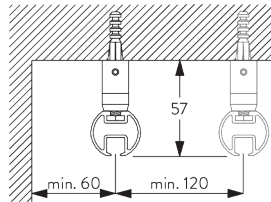

Mini hanger SG 6175

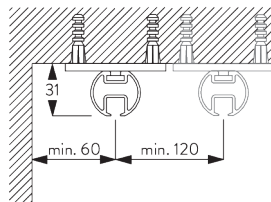

Bracket SG 6124

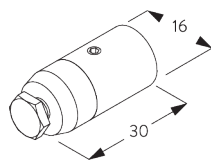

SG 6175
Mini hanger

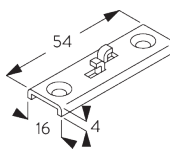

SG 6124
Bracket

C. WALL FITTING

Smart Fix

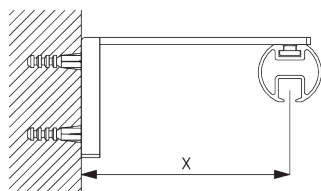

Smart Fix with slot SG 11206 - SG 11208:
Screw SG 10492 (M4x8) needed.

Smart Fix	X mm
SG 11206 / SG 11216	33-51
SG 11207 / SG 11217	53-71
SG 11208 / SG 11218	73-91
SG 11154	102-130
SG 11155	132-160
SG 11156	182-210

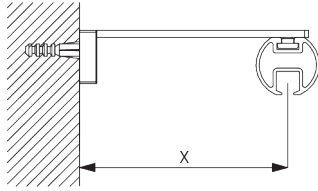

Square Smart Fix with slot SG 11216 - SG 11218:

Screw SG 10492 (M4x8) needed.

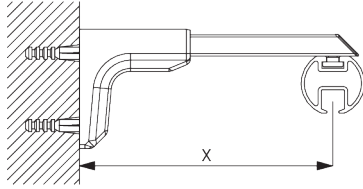

Universal Smart Fix SG 11154 - SG 11156:

Screw SG 11131 (M4x6) needed.

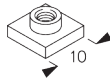

SG 6117

Slot nut



SG 10492

Pan head screw M4x8



SG 11131

Pan head screw with flange M4x6

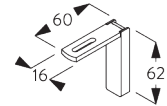

SG 11206

Smart Fix with slot 60 mm

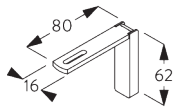

SG 11207

Smart Fix with slot 80 mm

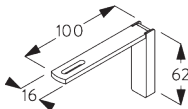

SG 11208

Smart Fix with slot 100 mm

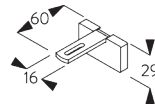

SG 11216

Square Smart Fix with slot 60 mm

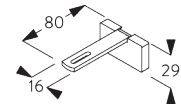

SG 11217

Square Smart Fix with slot 80 mm

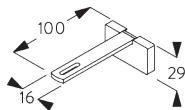

SG 11218

Square Smart Fix with slot 100 mm

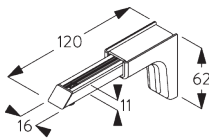

SG 11154

Universal Smart Fix 120 mm

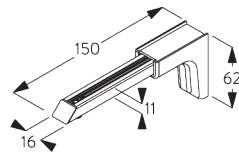

SG 11155

Universal Smart Fix 150 mm

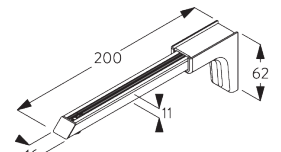

SG 11156

Universal Smart Fix 200 mm

SYSTEM OPTIONS

A. WAVE

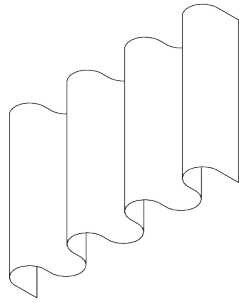

SG 11295

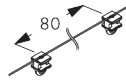

SG 11302



SG 2255



SG 2256

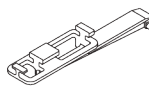

SG 6364



SG 6365

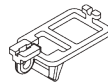

SG 6366

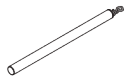

SG 10430-34

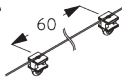

SG 11303

Standard components:

- SG 11295 End stop
- SG 11302 Wave 2C glider cord 80 mm

Optional components:

- SG 2255 Brake
- SG 2256 Brake
- SG 6364 Wave extension
- SG 6365 Wave hanger
- SG 6366 Wave carrier for draw rod
- SG 10430-34 Draw rod
- SG 11303 Wave 2C glider cord 60 mm



SG 3582

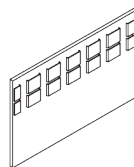

SG 6349

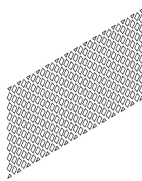

SG 6363

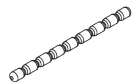

SG 10075



SG 10076

Curtain components:

- SG 3582 Hook
- SG 6349 Wave curtain tape
- SG 6363 Wave top hemming tape
- SG 10075 Lead weight 50 gr/m
- SG 10076 Fabric weight

Wave stack depth - 2C glider cord (standard components)

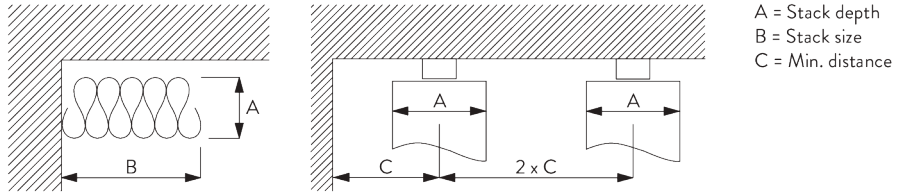







2C Glider cord SG 11302	Pockets between hooks	Approx. curtain fullness	Stack depth A	Stack size B*	Min distance C
80	6	~2.1	140	180 per metre of track	90
80	7	~2.3	160	180 per metre of track	100

2C Glider cord SG 11303	Pockets between hooks	Approx. curtain fullness	Stack depth A	Stack size B*	Min distance C
60	4	~2.1	100	230 per metre of track	70
60	5	~2.3	120	230 per metre of track	80





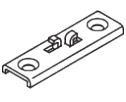
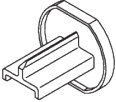



*Stack size B when using optional extension arm increases by 150 mm per curtain!

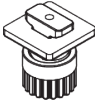
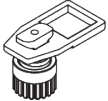

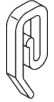
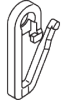

PARTS

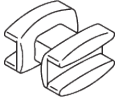
A. STANDARD PARTS

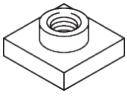
	SG 3599 Hook
	SG 6065 End stop
	SG 6086 Spring stop
	SG 6103p Profile
	SG 6124 Bracket
	SG 6630 End cover
	SG 11300 2C glider

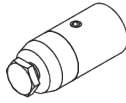
B. OPTIONAL PARTS

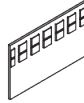
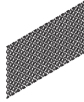
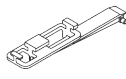
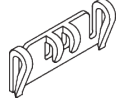
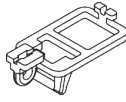
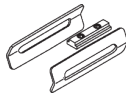
	SG 2255 Brake
	SG 2256 Brake
	SG 3012 Hook
	SG 3581 Hook
	SG 3582 Hook
	SG 3598 Eyelet
	SG 6004 Eyelet
	SG 6053 Spring stop
	SG 6057 Glider
	SG 6075 End stop with hook
	SG 6082 Glider
	SG 6094 Roller
	SG 6098 Roller
	SG 6117 Slot nut

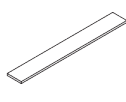
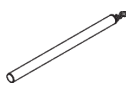
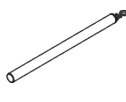
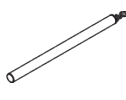
	SG 6175 Mini hanger
	SG 6240 Roller
	SG 6283 Roller
	SG 6349 Wave curtain tape
	SG 6363 Wave top hemming tape
	SG 6364 Wave extension
	SG 6365 Wave hanger
	SG 6366 Wave carrier for draw rod
	SG 6635 Connection bridge set
	SG 10075 Lead weight 50 g/m
	SG 10076 Fabric weight
	SG 10430 Draw rod 50 cm
	SG 10431 Draw rod 75 cm
	SG 10432 Draw rod 100 cm

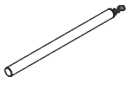

SG 10433

Draw rod 125 cm

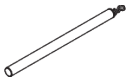

SG 10434

Draw rod 150 cm

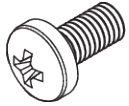

SG 10492

Pan head screw M4x8



SG 11131

Pan head screw with flange M4x6

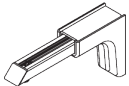

SG 11154

Universal Smart Fix 120 mm

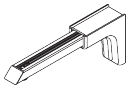

SG 11155

Universal Smart Fix 150 mm

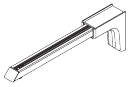

SG 11156

Universal Smart Fix 200 mm

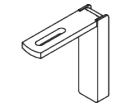

SG 11206

Smart Fix with slot 60 mm

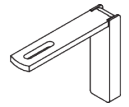

SG 11207

Smart Fix with slot 80 mm

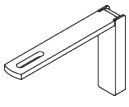

SG 11208

Smart Fix with slot 100 mm

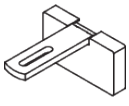

SG 11216

Square Smart Fix with slot 60 mm

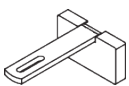

SG 11217

Square Smart Fix with slot 80 mm

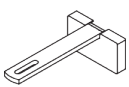

SG 11218

Square Smart Fix with slot 100 mm

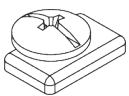

SG 11295

End stop



SG 11301

2C glider on strip

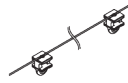

SG 11302

Wave 2C glider cord 80 mm

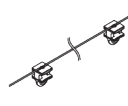

SG 11303

Wave 2C glider cord 60 mm

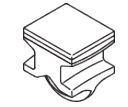

SG 11305

2C glider for direct sewing