

SG 8910

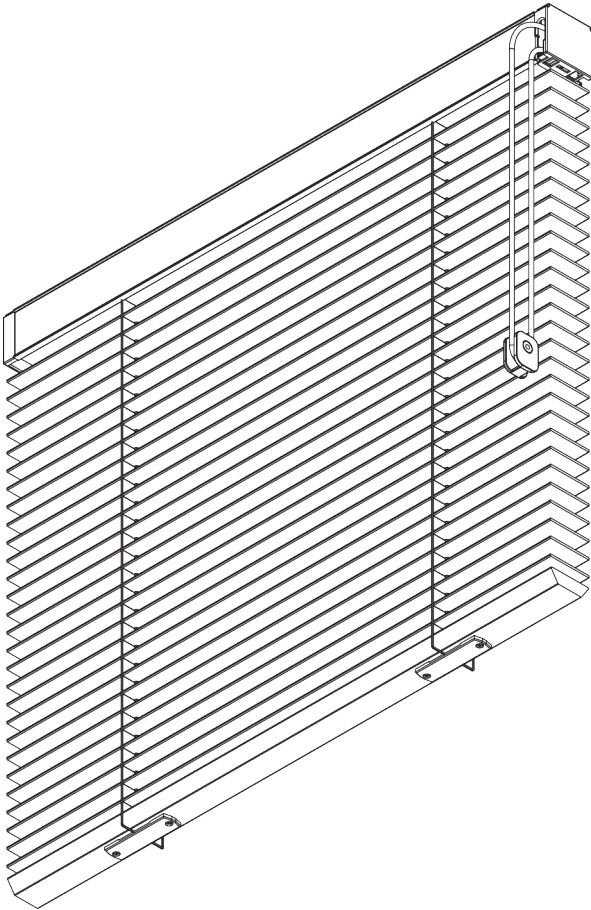
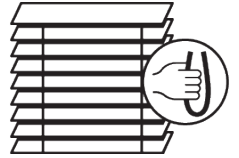

PRODUCT INFORMATION

- **Operation:** cord
- **Range:** L
- **Fitting:** ceiling, wall
- **Colours:** refer to Silent Gliss slat collection

Features:

- Optimised light control
- Speed controller: semi-automatic lowering of slats
- Wood, aluminium and leather slats
- Slat width: 50 mm
- Headrail slat cover
- Choice of ladder cord or decorative slat tape

SYSTEM SPECIFICATIONS

A. SYSTEM DIMENSIONS



Wood / Leather: 2.4 m
Aluminium: 3.6 m



65 cm

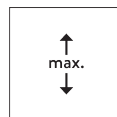

Wood / Leather: 2.75 m
Aluminium: 3.6 m

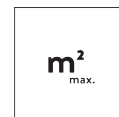

Wood / Leather: 4.6 m²
Aluminium: 10 m²

Slat stack heights

Note: stack size will be larger when tapes are used

Wooden										
Slat height (mm)	Tape (mm)	X	Slat width (mm)							
			60	90	120	150	180	210	240	275
50 mm		X	12	15	17	20	22	25	27	30
(cm)										
Leather										
Slat height (mm)	Tape (mm)	X	Slat width (mm)							
			60	90	120	150	180	210	240	275
50 mm		X	14	16	18	20	22	24	26	28
(cm)										
Aluminium										
Slat height (mm)	Tape (mm)	X	Slat width (mm)							
			100	200	300	360				
50 mm		X	10	13	17	20				
(cm)										

B. PROFILE

Profile information

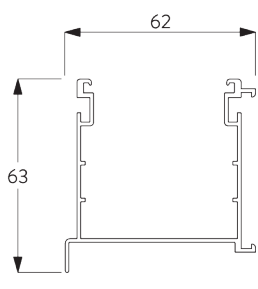

SG 8902

Profile

C. HOW TO MEASURE

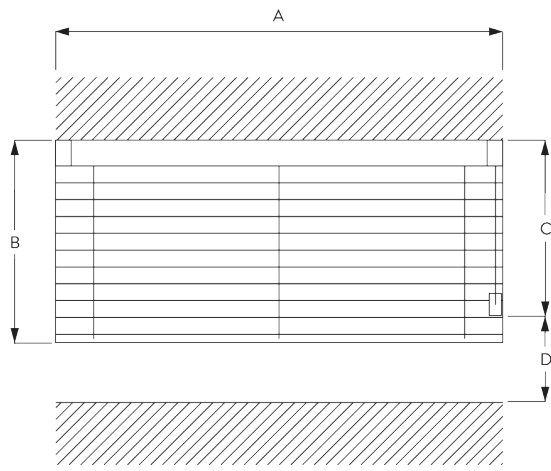

- A: System width
- B: System height
- C: Cord height
- D: Safety Retainer SG 10731 min. 150 cm above floor

D. SPECIFICATION TEXT

EN

Silent Gliss SG 8910 Cord Operated Venetian Blind. Supplied made to measure and complete comprising aluminium headrail SG 8902 incorporating matching colour slat, right or left-hand side single cord operation which permits raising, lowering and tilting of the slats. System fixed with universal brackets SG 8920 to ceiling or wall at 500mm intervals plus one at 100 mm from each end. Compliant to Child Safety legislation EN 13120 when used in conjunction with Cord Retainer SG 10731. Slat colours to be chosen from Silent Gliss 50 mm aluminium / wood / leather range.

SV

Silent Gliss SG 8910 Persienn med lina. Lameller 50 mm djup. Levereras i kundens mått komplett med aluminiumkassett SG 8902 med färgmatchande lameller och lina för manövrering i vänster eller höger sida för att hissa upp, ner samt vinkla lamellerna. Montering av kassett med beslag SG 8920 mot vägg c/c 500 mm samt 100 mm från varje ände. Uppfyller med linfäste SG 10731 barnsäkerhetsnorm EN 13120. Färg lameller väljs från Silent Gliss kollektion med 50 mm lameller i alu, trä eller läder.

NO

Silent Gliss SG 8910 Persienne med snor. Lameller med 50 mm dybde. Leveres på mål. Komplet med aluminiumkassett SG 8902 med matchende lameller og betjeningssnor på venstre eller høyre side. Kun en snor for betjening, vinkling av lameller og for å trekke opp. Kassetten monteres med beslag SG 8920 mot vegg c/c 500 mm samt 100 mm fra her ende. Med snorfeste SG 10731 oppfylles barnesikkerhetsnormen EN 13120. Farge på lamellene velges fra Silent Gliss kolleksjon med 50 mm lameller i alu, tre eller skinn.

DA

Silent Gliss SG 8910 persienne med snortræk. Leveres i ønsket længde og komplet, bestående af aluminiumkassette SG 8902 med lameller i matchende farver og snor til styring i venstre eller højre side, der gør det muligt at løfte, sænke og hælde lamellerne. Systemet fastgøres med universalbeslag SG 8920 til loft eller væg med afstande på 500 mm plus en på 100 mm fra hver ende. Overholder lovgivning om barnesikkerhed efter EN 13120., når det bruges i sammenhæng med snorholder SG 10731. Lamellernes farve vælges blandt Silent Gliss 50 mm aluminium / træ / læder program.

FITTING

A. FITTING INFORMATION

Fixing points

For detailed fitting information, visit the Silent Gliss website.

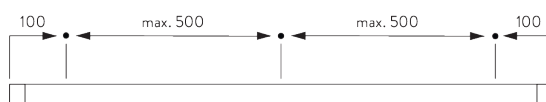

B. CEILING FITTING

Bracket SG 8920

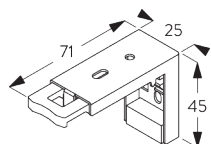
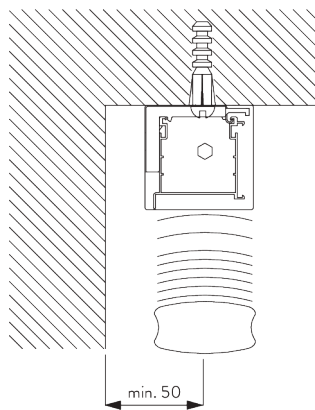

SG 8920

Bracket

C. WALL FITTING

Bracket SG 8920

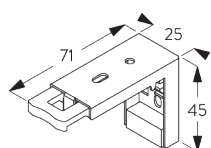
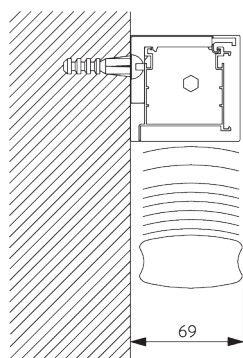

SG 8920

Bracket

D. FITTING WITH SIDE GUIDE OPTION

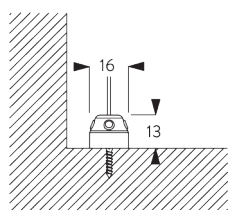

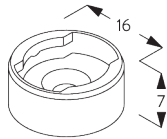

SG 8235
Side guide wire base short

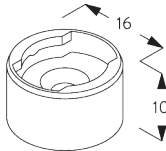

SG 8236
Side guide wire base long

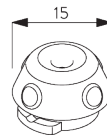

SG 8237
Side guide wire holder

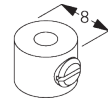

SG 8249
Side guide device

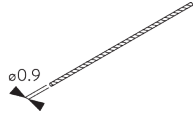

SG 10120
Side guide wire \varnothing 0.9 mm

SYSTEM OPTIONS

A. HEADRAIL SLAT COVER

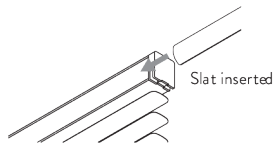

- A slat is inserted into the headrail for perfect matching of colours and materials to avoid the need to fit a cumbersome valance.
- For leather slat blinds there is the option of a leather covered headrail at an additional cost.
- Leather covered slats cannot be specified with decorative (external) slat tapes. The blind hardware is supplied matching the slat colour.

B. SIDE GUIDES

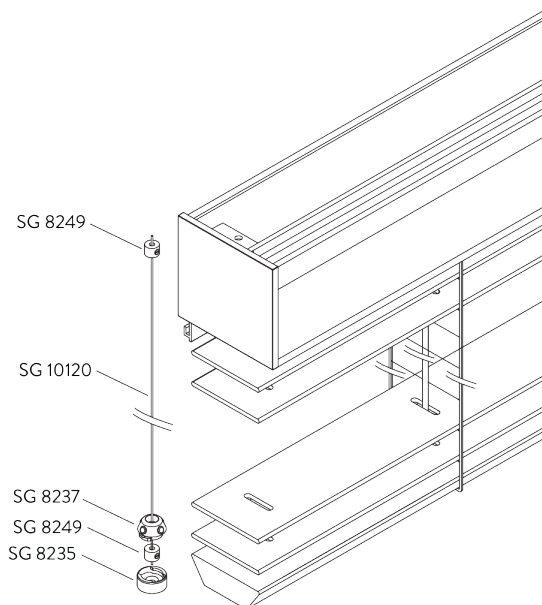

Additional parts:

- 2x SG 8235 Side guide wire base short
- 2x SG 8237 Side guide wire holder
- 4x SG 8249 Side guide device
- 2x SG 10120 Side guide wire \varnothing 0.9 mm

Note:

- Up to 15° from vertical

PARTS

A. STANDARD PARTS

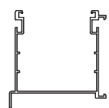

SG 8902

Profile

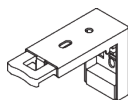

SG 8920

Bracket



SG 10731

Child safety retainer set

B. OPTIONAL PARTS



SG 8235

Side guide wire base short



SG 8236

Side guide wire base long



SG 8237

Side guide wire holder

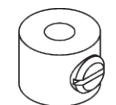

SG 8249

Side guide device



SG 10120

Side guide wire \varnothing 0.9 mm

